

# REDROCK<sup>4X4</sup>

## Tailgate Table

**J166367**

**2007-2018  
WRANGLER JK**

### **(1) Contents:**

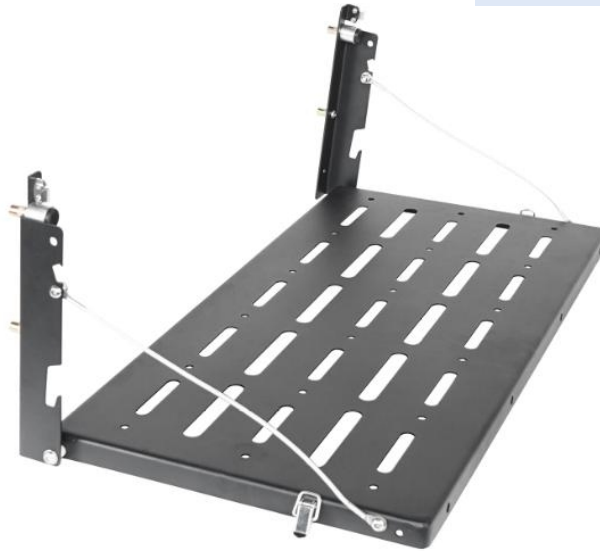

### **(2) Tools required:**

- a. Drill with 9.2-9.5mm Drill Bit
- b. Riveting Nut Tool
- c. 4mm Ratchet Allen Key Wrench



### **(3) Installation time:**

About 40 minutes, 1-2 people may be needed. Installation time may differ according to your mechanical skill level.

(PLEASE VERIFY ALL PARTS ARE PRESENT AND READ INSTRUCTIONS CAREFULLY BEFORE STARTING INSTALLATION!)

### **(4) Installation instruction:**

**Step 1: Find the template paper and cut it along the line. Then tape the paper on the tailgate.**

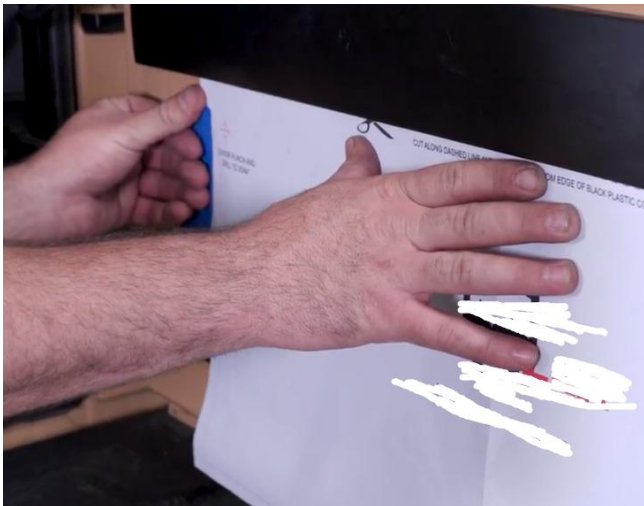
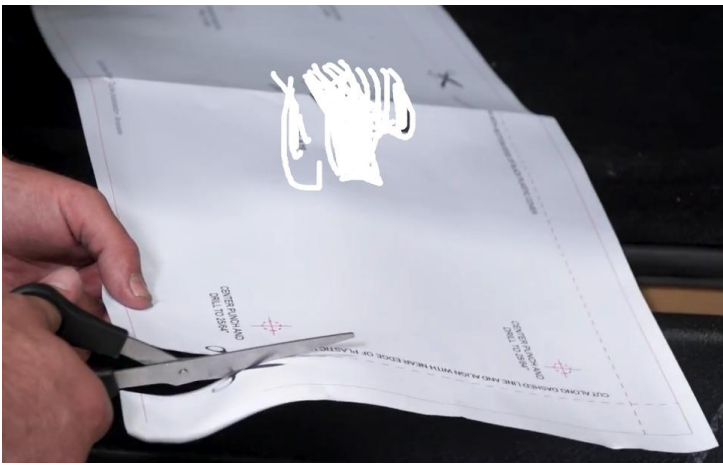

**Step 2: With the help of the template drill marking points, drill four mounting holes on the tailgate.**

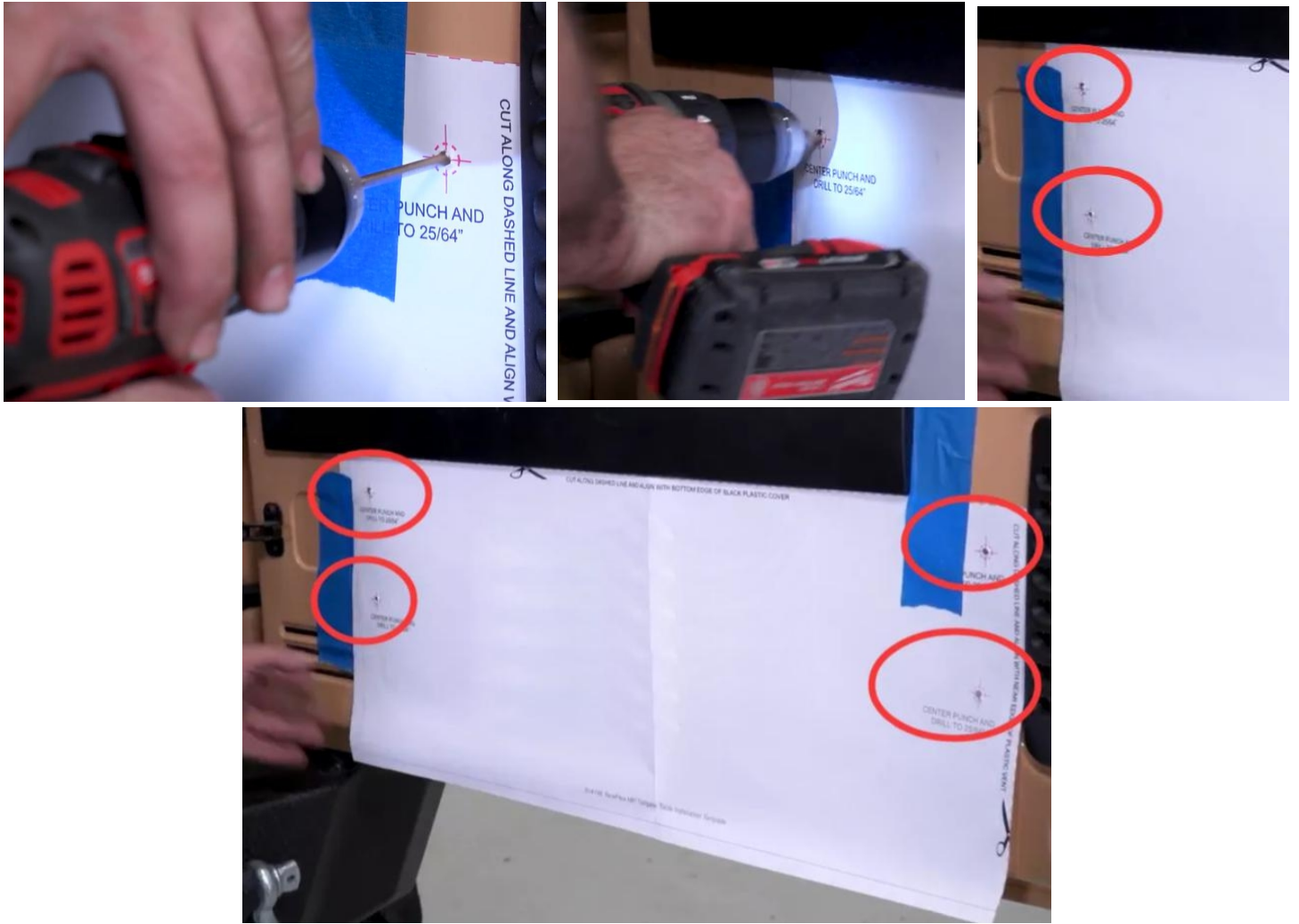

**Step 3:** Use the riveting nut gun with 6mm nut chuck to install the four riveting nuts.



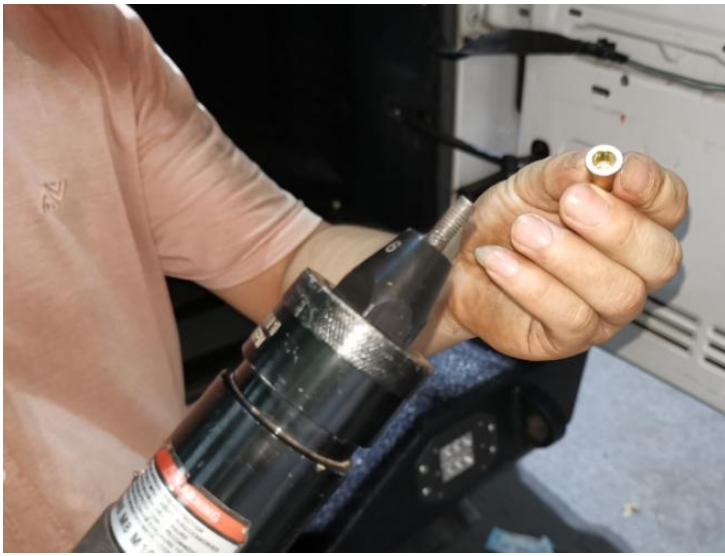

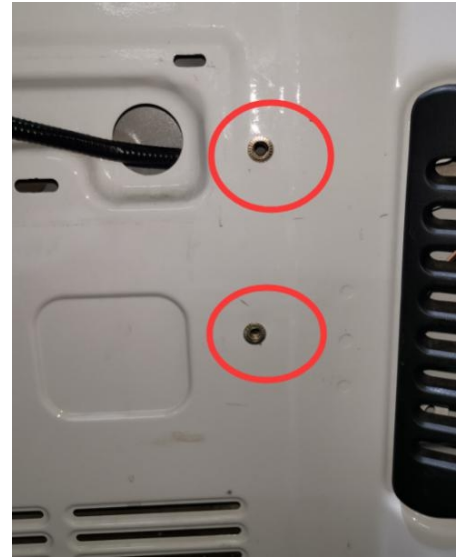
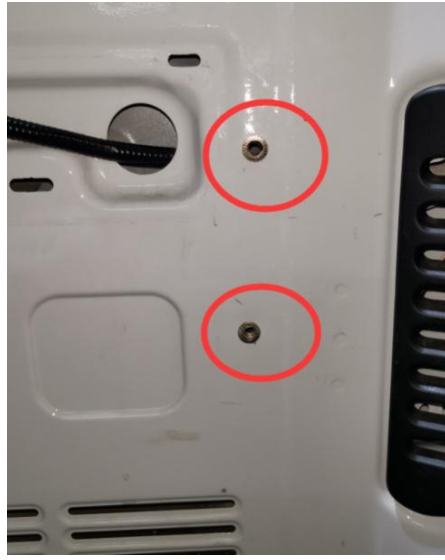

**Step 4:** Install the tailgate table with supplied bolts.

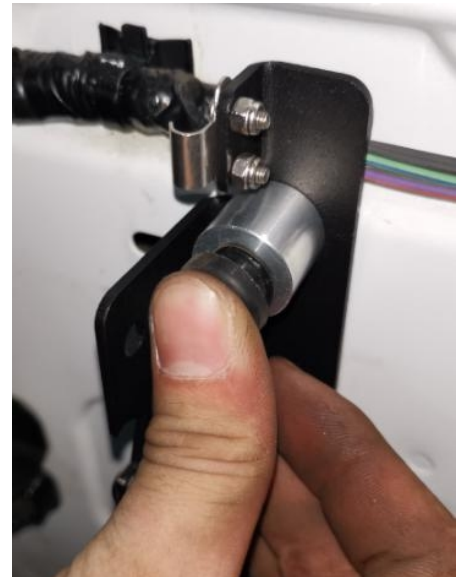

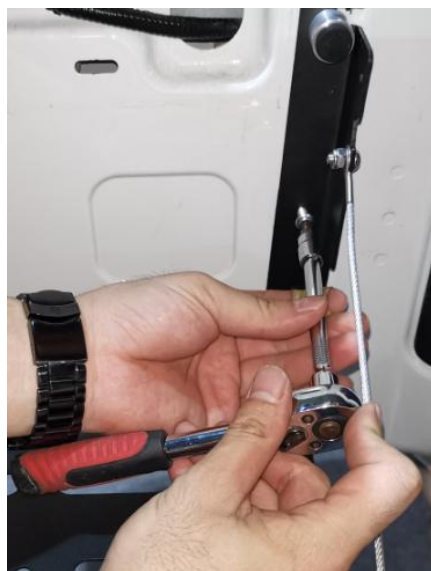

**Step 5:** Installation is now complete.

