

# INSTALLATION INSTRUCTIONS

JEEP

900 & 920



## PRE-INSTALLATION INSTRUCTIONS

These instructions have been designed for unaltered vehicles. Before you start, check for any variations. Each vehicle may dictate its own control mount and cable routing. Therefore, you will need to study the pictures and use your good judgement or seek professional help. Lift kits may govern how and where the cable is routed. **Always keep the cable away from heat (exhaust) and rough or sharp edges.** If you are concerned about lower cable damage or abrasion, we recommend cutting a length (about 3 feet) of 5/8" ID plastic or rubber hose (garden or heater) to be slid over the cable before assembly. Please keep in mind, **the warranty is void** on heat damaged or abused cables. Before drilling, check for any electrical wires, hoses, etc.

## LIMITED WARRANTY

4x4 Posi-Lok company warrants to the original retail purchaser that the 4x4 Posi-Lok is free from defects in material and/or workmanship for one (1) year from the purchase date when used under normal operating conditions on light trucks and SUVs. The warranty does not apply to 4x4 Posi-Lok Products that have been improperly engaged or installed. The consumer will be responsible for removing from the vehicle and returning to 4x4 Posi-Lok any defective item(s) with shipping costs prepaid. A copy of the original sales receipt is required for all warranty claims. The consumer must contact 4x4 Posi-Lok at (517) 278-7453 in order to receive a Returned Goods Authorization prior to shipping.

## LIMITATION OF WARRANTIES

The loss of use of the product or vehicle, loss of time, inconvenience, commercial loss or consequential damages are not covered. 4x4 Posi-Lok reserves the right to change the design of any product without assuming any obligation to modify any product previously manufactured.

This warranty gives you specific legal rights and you may also have other rights which may vary from state to state. Some states do not allow limitations on how long an implied warranty lasts or allows the exclusion or limitation of incidental or consequential damages, the above limitation or exclusion may not apply to you.

There are no warranties, expressed or implied, including any implied warranties of merchantability and fitness, which extend beyond the face hereof. Seller disclaims implied warranty of merchantability.

## LIMITATION OF LIABILITY

4x4 Posi-Lok's liability hereunder shall not exceed the purchase price of the product. 4x4 Posi-Lok shall not be liable for any incidental or consequential damages, whether direct or indirect, including, but not limited to, personal injury, property damage, economic loss, loss of profit, or the like. 4x4 Posi-Lok shall not be liable for any damages or defects of any kind whatsoever after installation of the 4x4 Posi-Lok, unless the purchaser has complied with any and all installation instructions. The limitation of liability as set forth above shall apply even to claims of negligence or strict liability against 4x4 Posi-Lok.

## OPERATING INSTRUCTIONS

**Engagement:** Relax the throttle - no acceleration or deceleration. Shift the transfer case to desired 4x4 mode. Press the button and pull the cable into full engaged position. (Light on-off throttle action while pulling on the handle will help align gears for smooth engagement.) Release the button.

**Disengagement:** Place transfer case in 2WD mode. Press the button, push the cable into full disengaged position, and release the button. If moving, light on-off throttle action will help to relax the drive train. Disengagement may be easier with some models if the vehicle is stopped and put into reverse for a few inches while pushing the cable in.

### Notes:

2WD Lo-range—Place the transfer case in 4WD Lo range, but do not engage the 4x4 Posi-Lok system. **Warning: Do not apply excessive torque in this mode.**

If a differential gear locker is used in the front axle, the driver can manually unlock the front axle to make very tight right turns on hard ground, then re-lock to continue.

Save these instructions and place with owner's manual.

## KIT #900

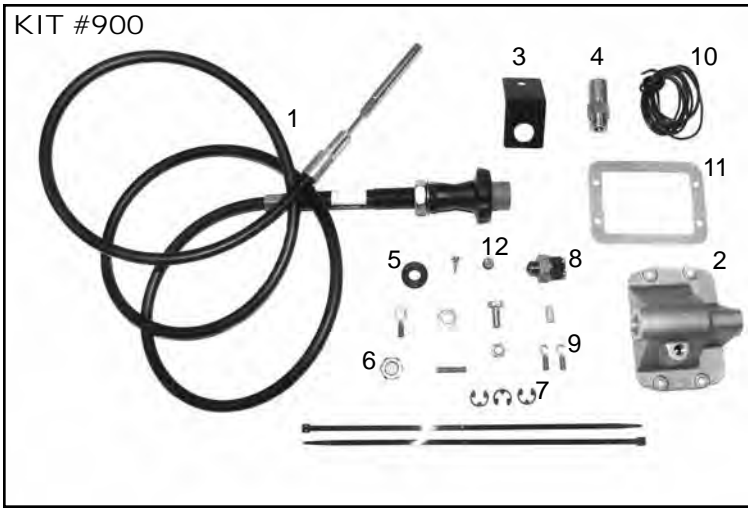

## PARTS

- |                         |                    |
|-------------------------|--------------------|
| 1. Cable                | 7. E-clips         |
| 2. Housing              | 8. Light switch    |
| 3. Dash bracket         | 9. Wiring fittings |
| 4. Light switch adapter | 10. Wiring         |
| 5. Firewall grommet     | 11. Housing gasket |
| 6. Jam nut              | 12. Vent Plug      |

## SPECIAL INSTRUCTIONS

To engage this 4x4 Posi-Lok, depress the button and pull the cable.

## SPECIAL TOOLS

- RTV silicone sealant
- 5/8" drill bit (unibit #3 recommended)
- Unibit #3 or 11/16" drill bit

## JACKING

Support the vehicle frame with the front wheels off of the ground and at full travel. Use jack stands and all safety precautions. **Failure to raise the vehicle so that the front axle fully drops will void the warranty and may cause cable damage.**

## VACUUM

Before you remove the CAD (Central Axle Disconnect) vacuum actuator, locate the source of vacuum transfer case switch. Using the vacuum cap provided, plug off as close to the engine source as possible without disrupting any other vacuum requirements. (Fig. 1)

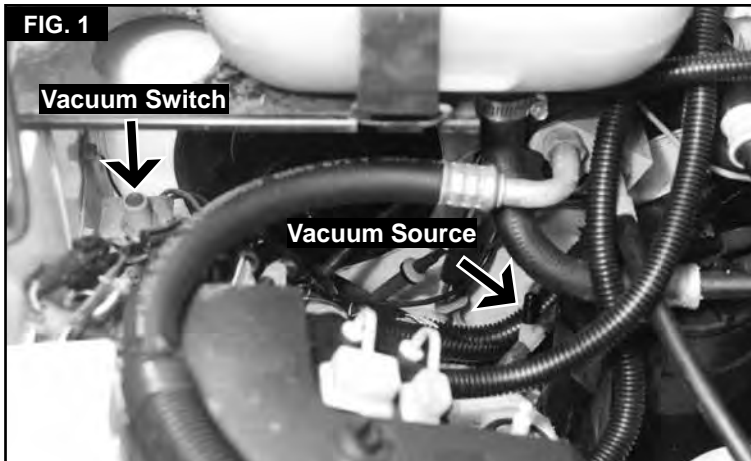

## FORK UPGRADE

When the CAD cover is unbolted, some gear lube will run out. Inspect the fork and fork clips/wear pads for any necessary replacement. We offer a replacement aluminum fork part number **PSL100**.

### Replace the fork if:

- It is broken and/or chipped in any places (Fig. 2)
- The end of the fork moves more than 1/4" in either direction (Fig. 3) and/or if it does not fit tightly on the shaft.
- The hole in the fork is oblong.

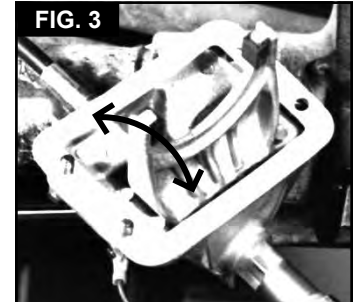
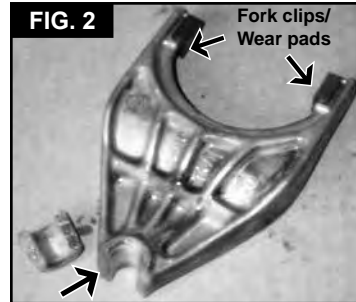

## YJ INSTALLATION - YJ ONLY

1. Use a straight edge to align the hole to be drilled in the firewall (Fig. 4A) with a hole of choice on the dash rail (Fig. 4B). Be sure to check for electrical wires, hoses, etc. before drilling the 5/8" hole in the dash rail (Fig. 4B) and a 5/8" hole in the firewall (Fig. 4A).
2. Install dash bracket for proper hole and cable alignment. **Note: You may need to bend the dash bracket by placing it between two small blocks of wood in a vice and tap down with a soft face hammer or lift up with a non-marring tool.** (Fig. 5)
3. Remove nut and washer from cable. Slide the end of the cable through the dash bracket and place nut and washer over the end of the cable. Cut the grommet (# 5 on the kit picture, page 2) on one side to form a "C" and thread in the firewall hole around the cable (Fig 9). Secure cable to dash bracket by screwing nut and washer.

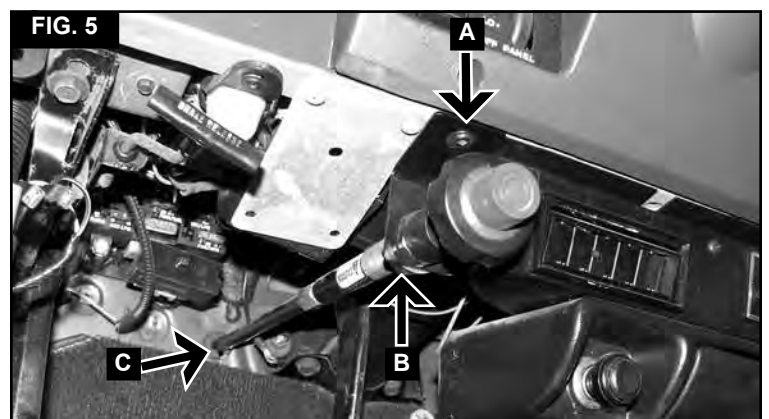
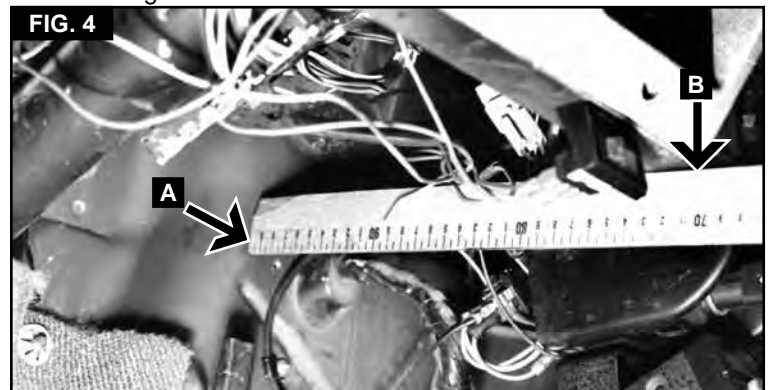

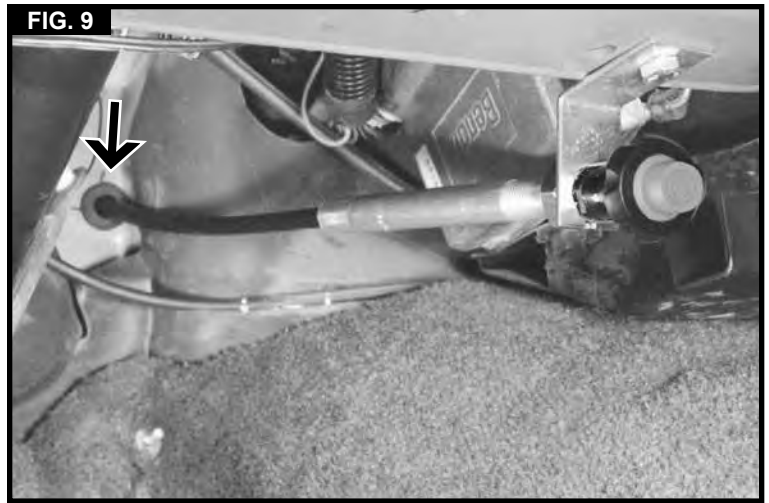
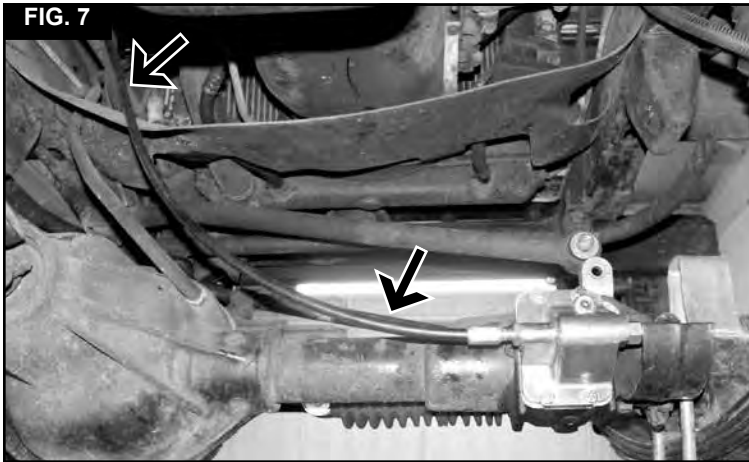
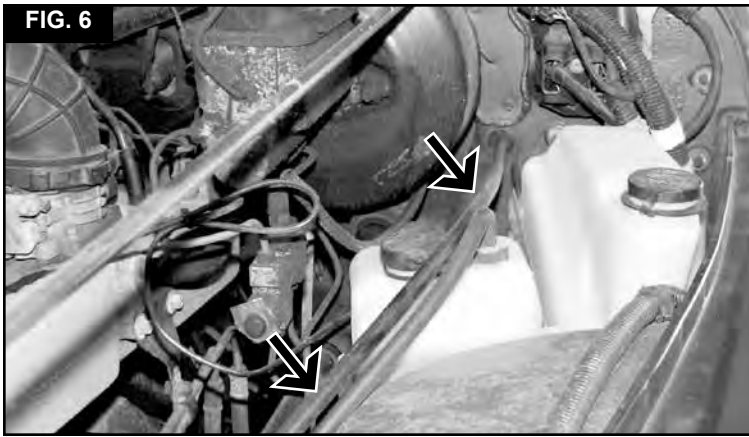

### XJ & MJ INSTRUCTIONS - XJ/MJ ONLY

1. Trim the insulation from the area below the throttle cable approximately 4". Use a straight edge to align the hole to be drilled in the firewall (Fig. 8A) with a hole of choice on the dash rail (Fig. 8B). Mark the firewall about 2" below the throttle cable and to the right of the throttle lever. Keep in mind the throttle lever movement, and do not allow the 4x4 Posi-Lok cable to touch the lever. Remove the throttle bracket from the cowl and drill a 5/8" hole in the dash rail (Fig. 8B) and a 11/16" hole in the firewall (Fig. 8A).
2. Install the dash bracket for proper hole alignment. **Note: You may need to bend the dash bracket by placing it between two small blocks of wood in a vice and tap down with a soft face hammer or lift up with a non-marring tool.**
3. Remove nut and washer from cable. Slide the end of the cable through the dash bracket and place nut and washer over the end of the cable. Cut the grommet (# 5 on the kit picture, page 2) on one side to form a "C" and thread in the firewall hole around the cable (Fig. 9) For XJ and MJ models install the throttle assembly and check operation. Secure cable to dash bracket by screwing nut and washer.

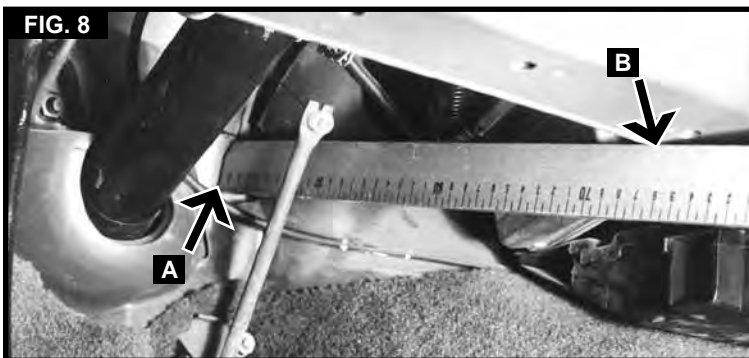

### OE ACTUATOR REMOVAL - ALL MODELS

4. Place a drain pan under the actuator housing. If equipped, remove the wires from OE light switch (Fig. 10).
5. Remove the vacuum connections at the diaphragm (Fig. 11A). Unbolt the diaphragm shield from the axle tube. Remove the vent hose from the housing, if equipped. Remove and save the four mounting bolts from the housing. Remove the housing from the axle tube (Fig. 12).
6. Cover the opening with a cloth. Thoroughly remove all gasket material from the surface with a wire brush or scraper (Fig. 12A). **Note: Be sure not to get any material inside the axle tube during this process.** Remove the cloth when finished.
7. Remove the three e-clips from the O.E. diaphragm shaft. Remove vacuum diaphragm from O.E. housing to extract the O.E. fork. **Note: Force may be required.**

**FIG. 10**

**IF THERE IS NO ELECTRICAL SWITCH ON THE ORIGINAL COVER:**

Make up 5" lead with #8 wire (supplied) and 1/4" lug terminals and connect to upper cover mounting bolt (ground)

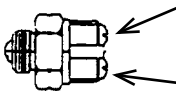

Route another line up to OEM vacuum switch; cut and splice to OEM wire with butt splice provided. On some YJ's the switch is under the battery tray. For XJ applications, see Fig. 16.

**WITH ELECTRICAL SWITCH ON ORIGINAL COVER:**

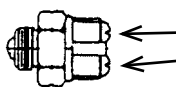

Cut off OEM terminal end, add #8 terminals to wires; OE wires, either wire to either terminal



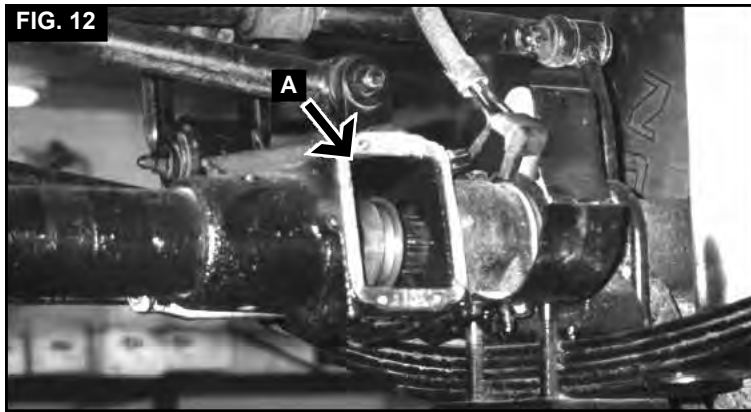

## DIFFERENTIAL MOUNTING - ALL MODELS

8. After rechecking the cable routing to the axle CAD (Fig. 6 & 13) we suggest:

**XJ & MJ:** Route over the master cylinder and under the steering shaft next to the frame rail.

**YJ:** Route over the throttle cable next to the master cylinder—down between the steering shaft and the frame in front of the fuel lines.

Use your good judgement and remember—body to axle flex and also heat from the exhaust can damage the cable.

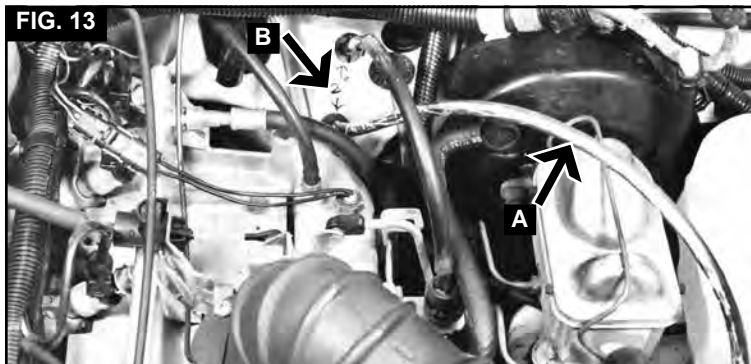

9. Remove the axle vent tube from O.E. housing. If your vehicle was not equipped with a vent tube on the CAD, plug the hole in the supplied housing with the supplied pipe plug. (Parts List #12)

10. Install the light switch adapter (Parts List # 4) in to the new CAD housing (Parts List # 2) using RTV Sealant. (Fig. 14C) Note: The switch adaptor will thread hard in to the aluminum house. This is a liquid tight seal and is suppose to thread in hard.

11. Screw the light switch (Parts List # 8) on to the adapter using RTV sealant. (Fig. 14 D)

12. Thread the jam nut (#6 in kit picture) onto the cable conduit, then place the fork into the new housing (Fig. 14A) and thread the cable end into the housing and fork, before installing 3 e-clips (#7 in kit picture). Recheck that the fork is correctly installed. Now install the two e-clips on the cable side first (Fig. 14B), then the last e-clip on the switch side. Be sure you are right, e-clips are hard to remove and easily lost.

**Note: When fork is installed correctly, it will be offset toward the cable.**

13. Thread cable into the CAD housing about 1/2" (Use RTV Sealant.) Now push the handle into the full disengaged. Pull the handle to the full engaged position. Check to see that the stop e-clip is resting against the housing. This is the full engaged position. Adjust by turning the housing on cable threads and be sure that the fork shaft does not touch the cable thread end, but the e-clip is touching the housing. The housing must be removed from the axle in order to adjust fork travel.

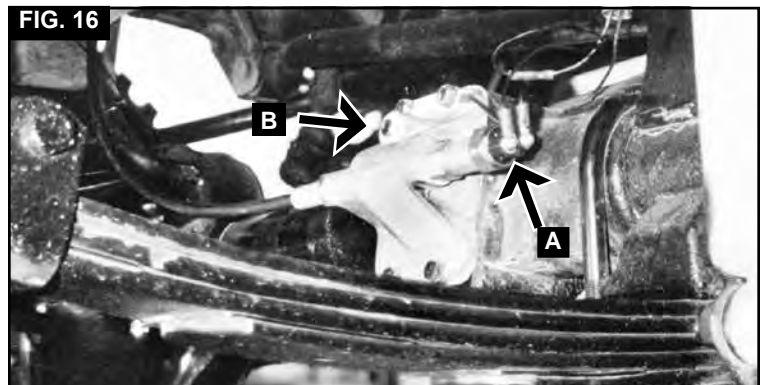
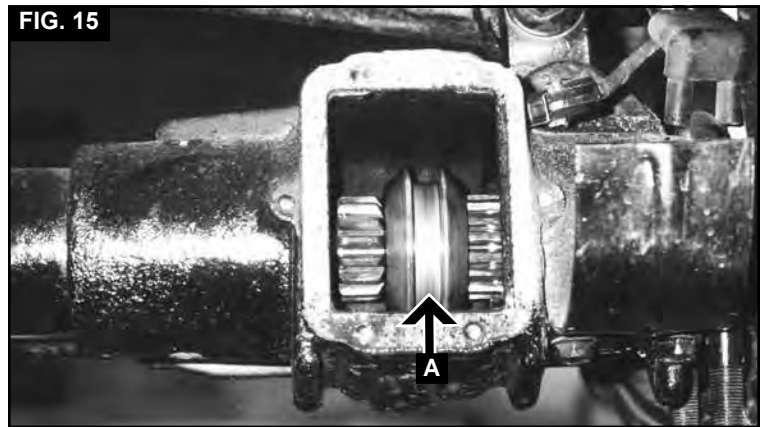
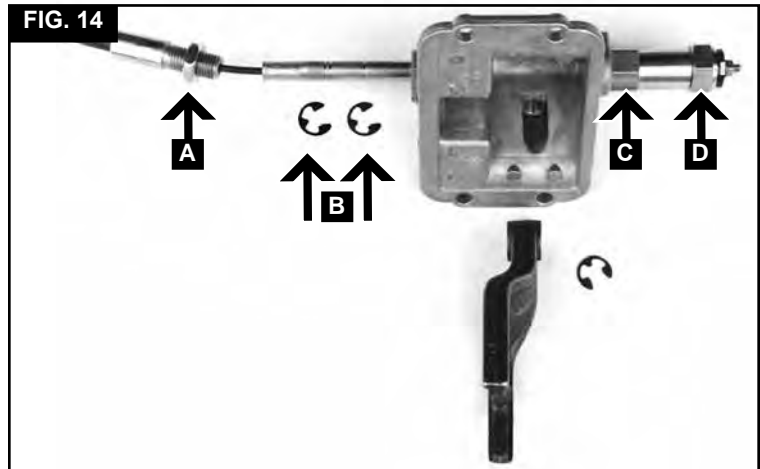

14. Align the axle collar with the axle spline, (Fig. 15) rotating the front drive shaft or wheel will help (See Pre-Installation Information). Check that both wear pads are in good condition and are clipped onto fork fingers. Install the gasket and align the fork fingers into the collar groove (Fig. 15A) and bolt the housing to axle. Do not use RTV on gasket as it will cause gasket to distort. Reinstall the original shield at this time.

15. Tighten the cable jam nut against the housing. Hook up the switch (Fig. 10 & 16A) and the vent tube, if applicable.

16. Turn the ignition key on—with the engine off. Put the transfer case in 4x4 mode, and test the front axle CAD engagement and disengagement. Also test the light operation. You may need to rotate the drive shaft or one wheel a few degrees to achieve full engagement - the last 1/4" is very important.

17. Lower the vehicle. **Optional:** Place the 3' of 5/8" heater hose mentioned in the pre-installation instructions over the cable at the point of wear on the differential housing.

18. Check the gear lube level. Read the operating instructions and road test.

19. Recheck the cable routing during each service job to see that it is not hitting the drive shaft or the steering shaft. Severe wheel travel may require some readjustment to cable routing.